



SPARO
Foldable nursing bed



SPARO

Folding bed especially suitable for home care.

The biggest advantage of this bed is its folding construction.

The folding construction allows the bed to be easily and quickly folded down to smaller dimensions. This makes the bed easier to handle during moving, and it fits easily into smaller spaces, such as a car, elevator or when carrying it up stairs.

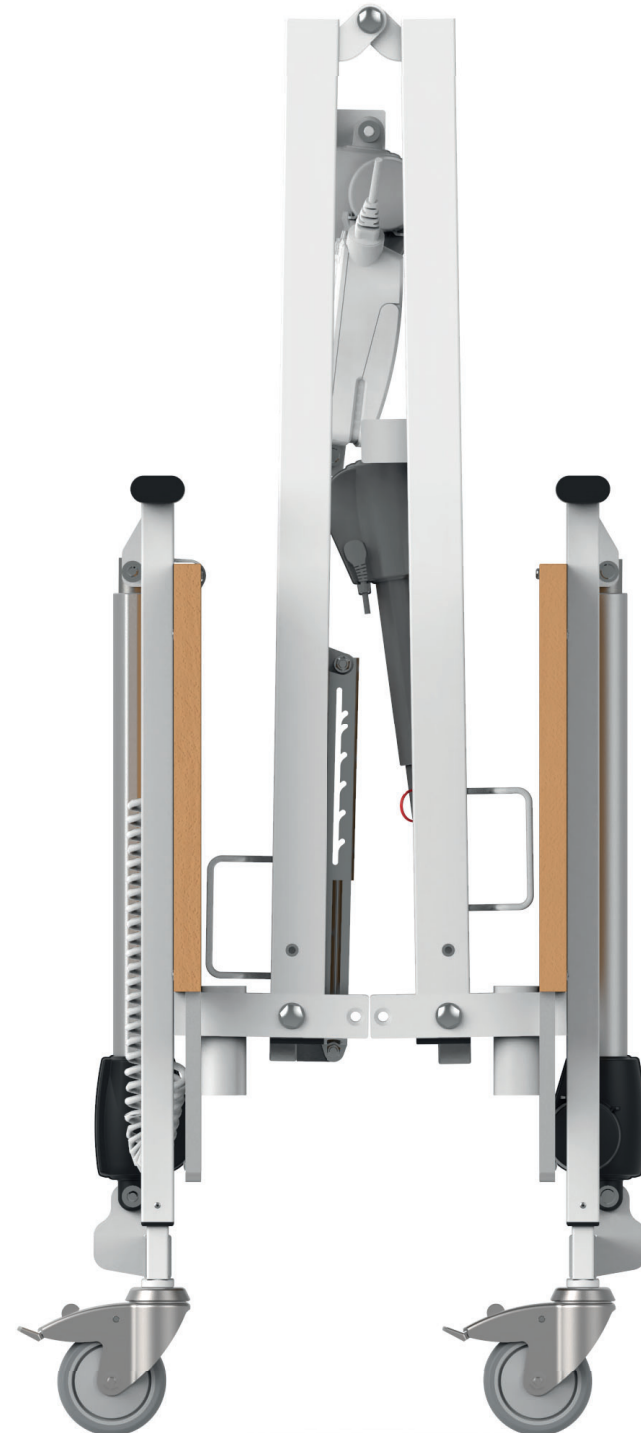



Folding construction

The biggest advantage of this bed is its foldable construction.

The folding design allows the bed to be folded down to a smaller size quickly and easily. This makes the bed easier to handle during a relocation, and it fits easily into smaller spaces, such as a car, elevator or when carrying it up stairs.



200 kg



Patient control

The bed can be optionally equipped with an ergonomic patient control, which is always at hand of the patient and allows easy control of all basic functions.

Increased load capacity

The solid and stable construction with a safe operating load of up to 200 kg provides safe support even when caring for client with higher weight. Thanks to the materials and technologies used, extremely high durability is ensured even under repeated increased loads.

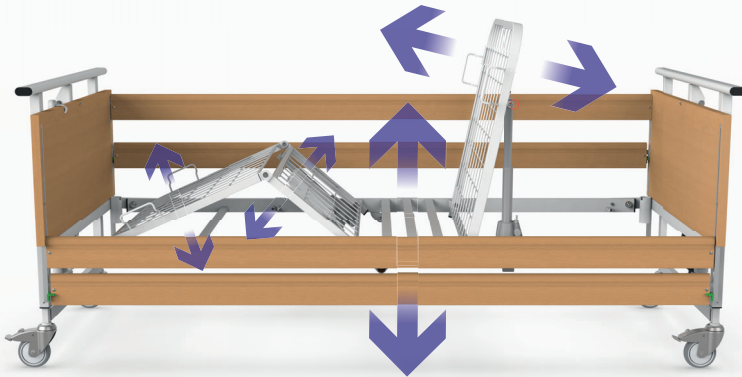
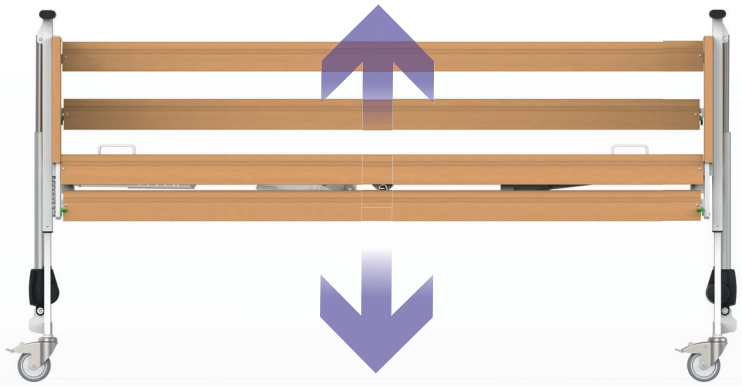

Foldable side rails

The safety of the client on the bed is ensured by folding side rails. The easy folding of the side rails with two independent movements significantly reduces the risk of accidental lowering. The folded side rails are positioned sufficiently below the mattress level to allow easy exit from the bed.

Comfortable positioning

The increased range of the bed lift reduces the strain on staff and facilitates the client handling. The reduced minimum height of the mattress platform assists the client in exiting the bed. The electric positioning of the back and thigh section in combination with the mechanical positioning of the calf section allows a wide range of adjustment of the individual parts of the mattress platform. The staff and client can conveniently adjust the individual positions using the hand control.

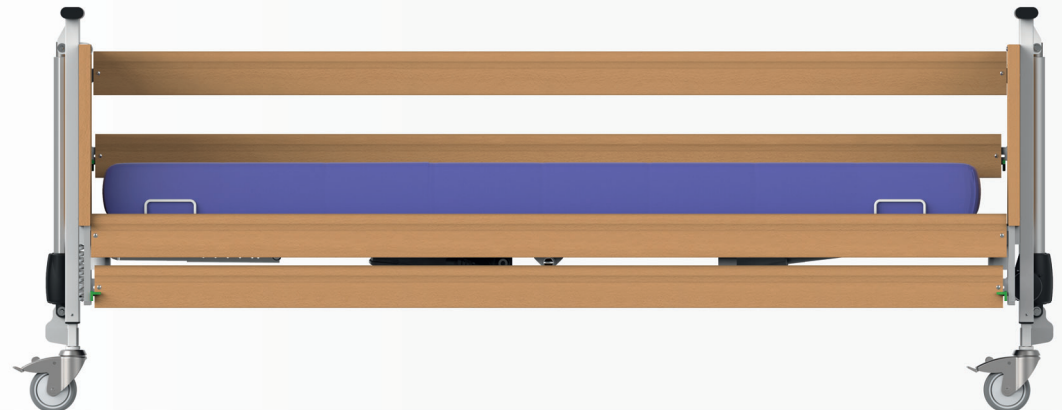

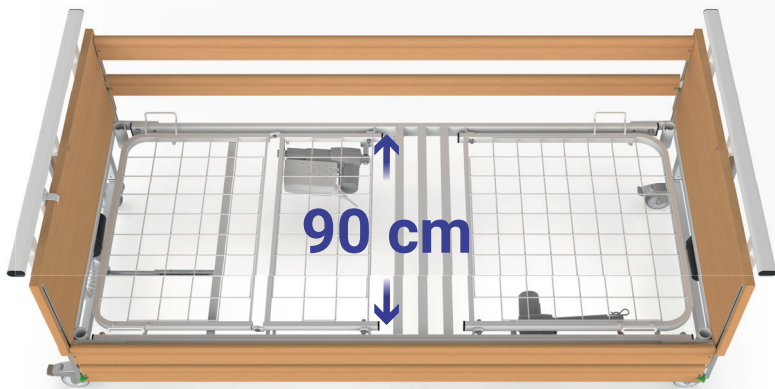

Width of the mattress platform
The optimal width of the mattress platform ensures maximum comfort for the patient and easy handling of the bed.

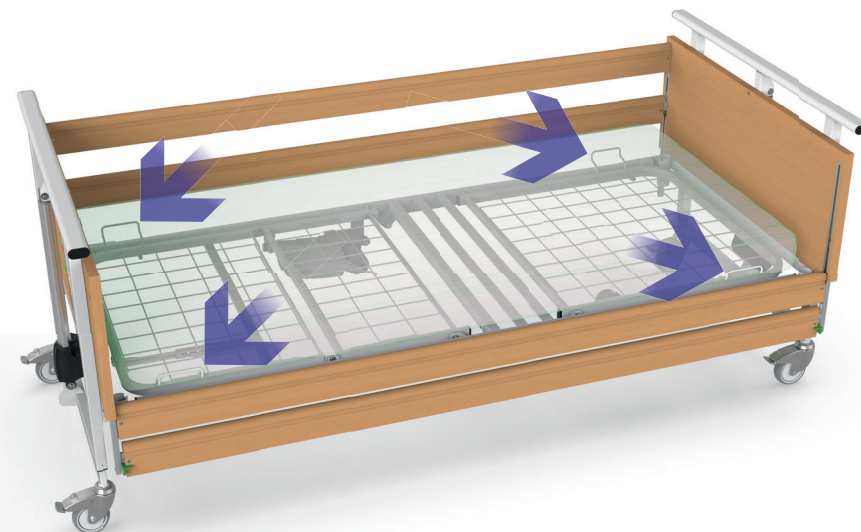

Mattress holders
The mattress holders ensure the optimal position of the mattress when positioning the mattress platform.

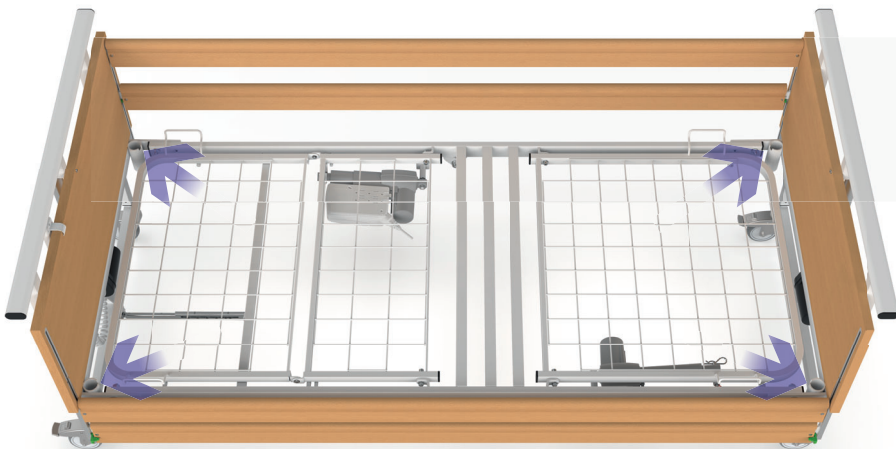

Universal accessories holders
Two are located at the head board and two at the foot board. They allow the use of accessories such as: lifting pole and handle, IV pole, monitor holder, additional side rails, bedside lamp or extension kit.

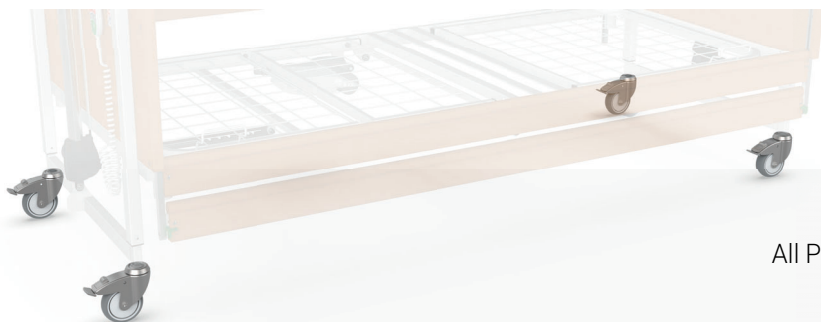
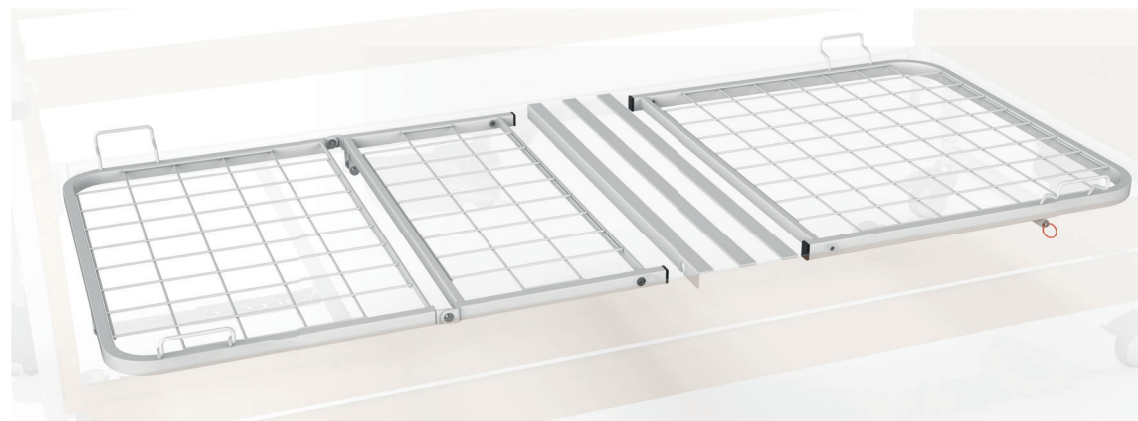

Castors TENTE
All PROMA REHA beds are equipped with TENTE branded castors.

Mattress platform
The mattress platform is made of a high-quality wire construction. The main advantages of these materials are their high resistance to chemical preparations, surface stability and resistance to wetting.

Trendelenburg, Antitrendelenburg



Choice of design

Being able to choose the design of care beds allows you to create an esthetic and welcoming space that can help improve mood, comfort and reduce stress.



Technical parameters

| | |
|---|-----------------|
| Mattress platform (length x width) | 200 x 90 cm |
| Outer bed dimensions (length x width) | 219 x 104 cm |
| Height of the mattress platform..... | 40 - 80 cm |
| Mattress platform | Metal wire mesh |
| Safe operating load | 200 kg |
| Maximum patient weight | 165 kg |
| Application environment for bed use | 3, 4 |
| Side rails | Type UNI |
| Trendelenburg / Antitrendelenburg..... | 12° / 12° |
| CPR..... | Yes |
| Universal accessory holders | 2x |
| Castors | 100 mm, metal |

Mattress

| | |
|--|-------------|
| Recommended mattress (length x width)..... | 200 x 90 cm |
| Mattress thickness in normal using | 14 cm |
| Recommended minimal mattress size..... | 12 cm |
| Recommended maximal mattress size | 22 cm |

